

Proportional Pilot-operated Pressure Reducing Valve(BYJ)

Technical specification



Specification	03	06
Maximum pressure (MPa)	31.5	31.5
Maximum flow (l/min)	150	300
Secondary pressure Regulating range (MPa)	See model description	
Rated current (mA)	800	
Coil resistance (Ω)	19.5	
Hysteresis (%)	< ± 2.5	
Repeatability (%)	< ± 2	
Cleanliness	Filter is recommended for the highest fluid pollution degree;the lowest specific filtration resistance according to ISO 4406 (C) 20/18/15.	

Comprised of proportional directly-operated relief valve, pressure limiting valve and reducing valve, this product controls a secondary pressure from the system pressure according to value of input current.

Model instruction

BYJ - * - * * Y - 9X *

Proportional pilot-operated pressure reducing valve		Remarks
Specification 03 DN10 06 DN20		Design serial number
Secondary pressure regulating range 7 7MPa 16 16MPa 25 25MPa		Control oil Y intl cntrl extl disch
	Default D	Without check valve With check valve

Code symbol

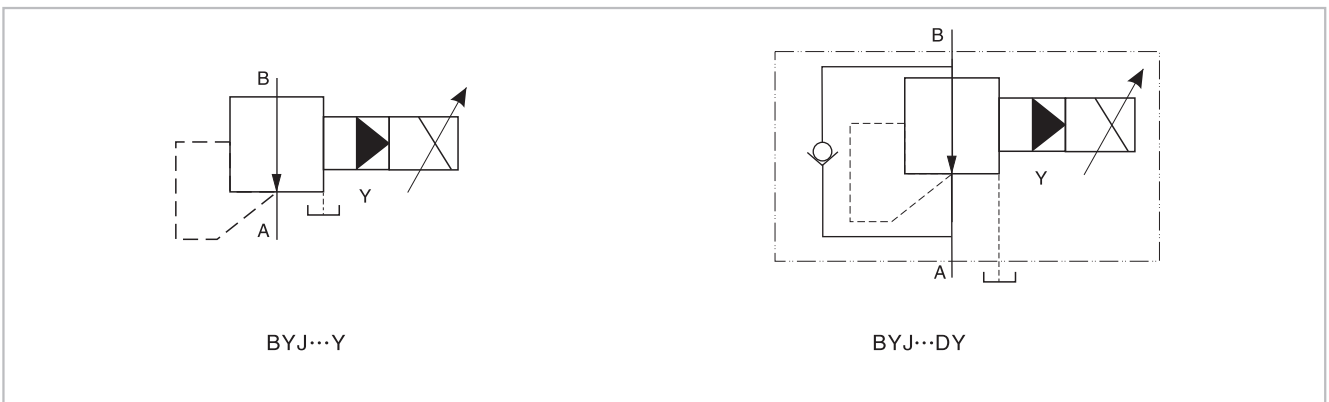

Proportional Pilot-operated Pressure Reducing Valve(BYJ)

03、06、10 Model characteristic curves (Measured at $v=36 \times 10^{-6} \text{m}^2/\text{S}$ $t=50^\circ\text{C}$)

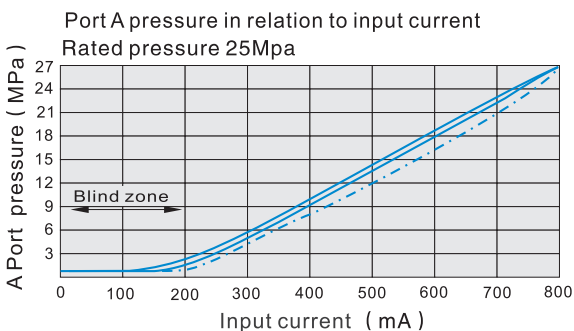
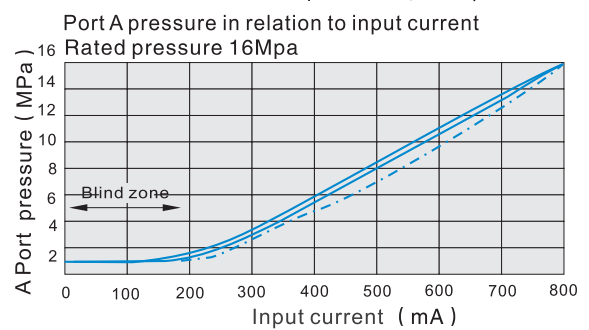
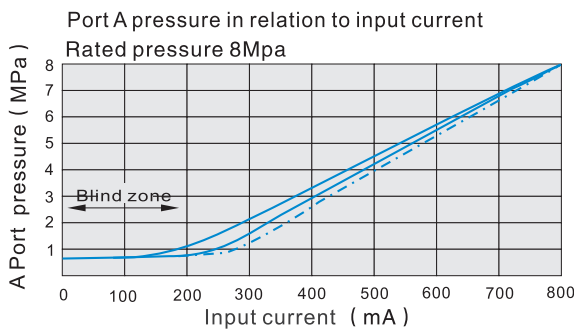
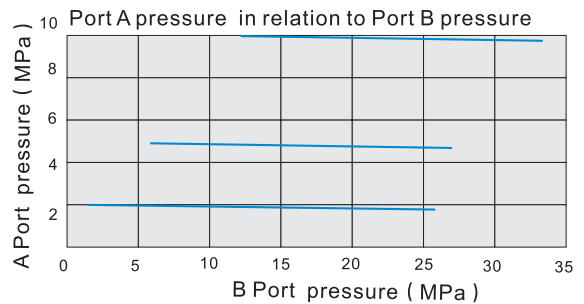
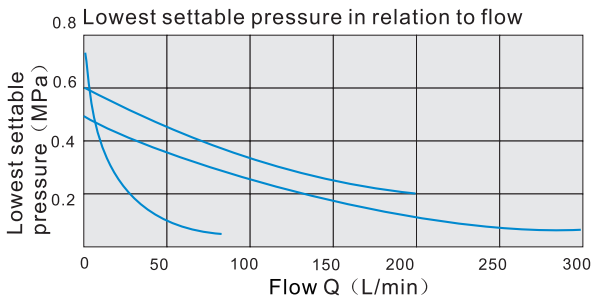
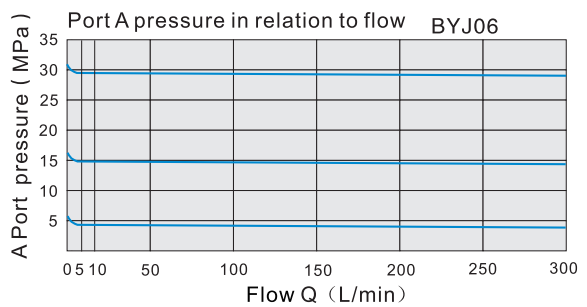
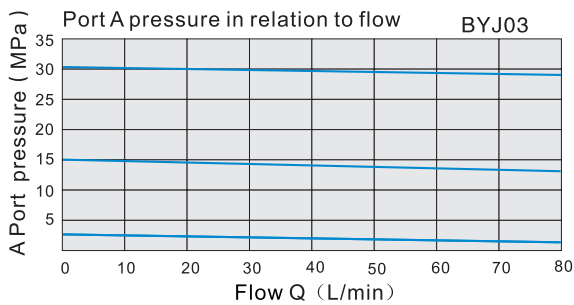
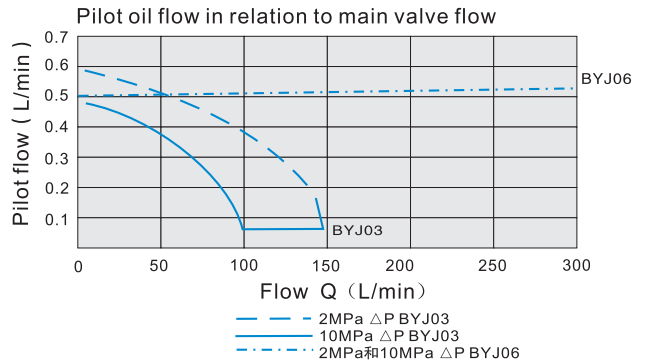
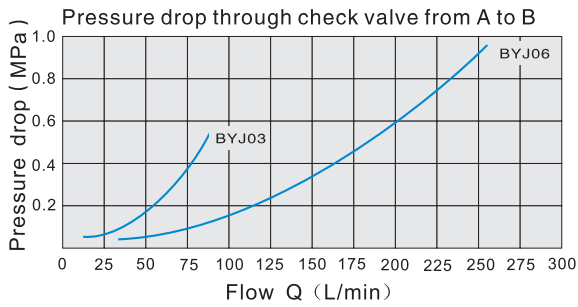

Delay:
With shake dither ———
No Shake - - - - -

BYJ03、06 Model are tested under 27L/min.
Note: In order to get the lowest rated pressure,
pilot initial current is not more than 0.1A

Proportional Pilot-operated Pressure Reducing Valve(BYJ)

External dimensions

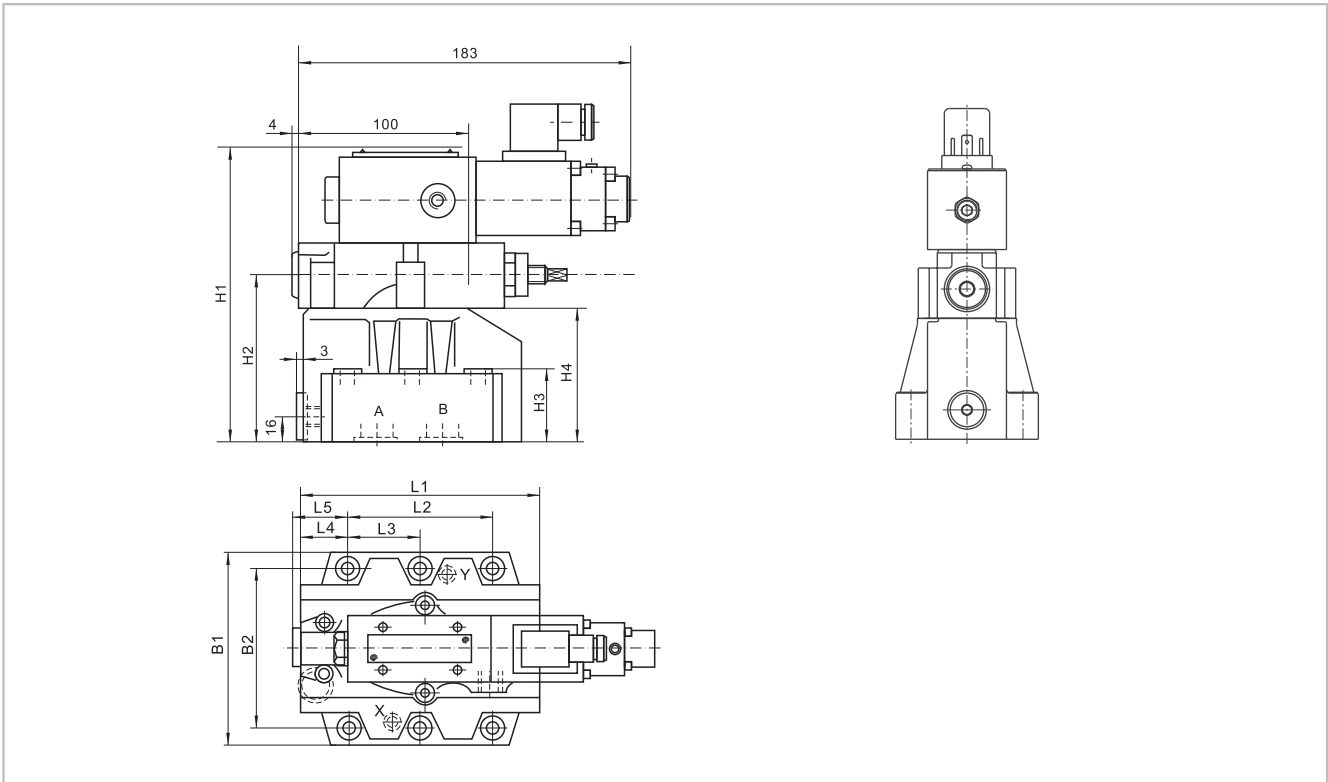
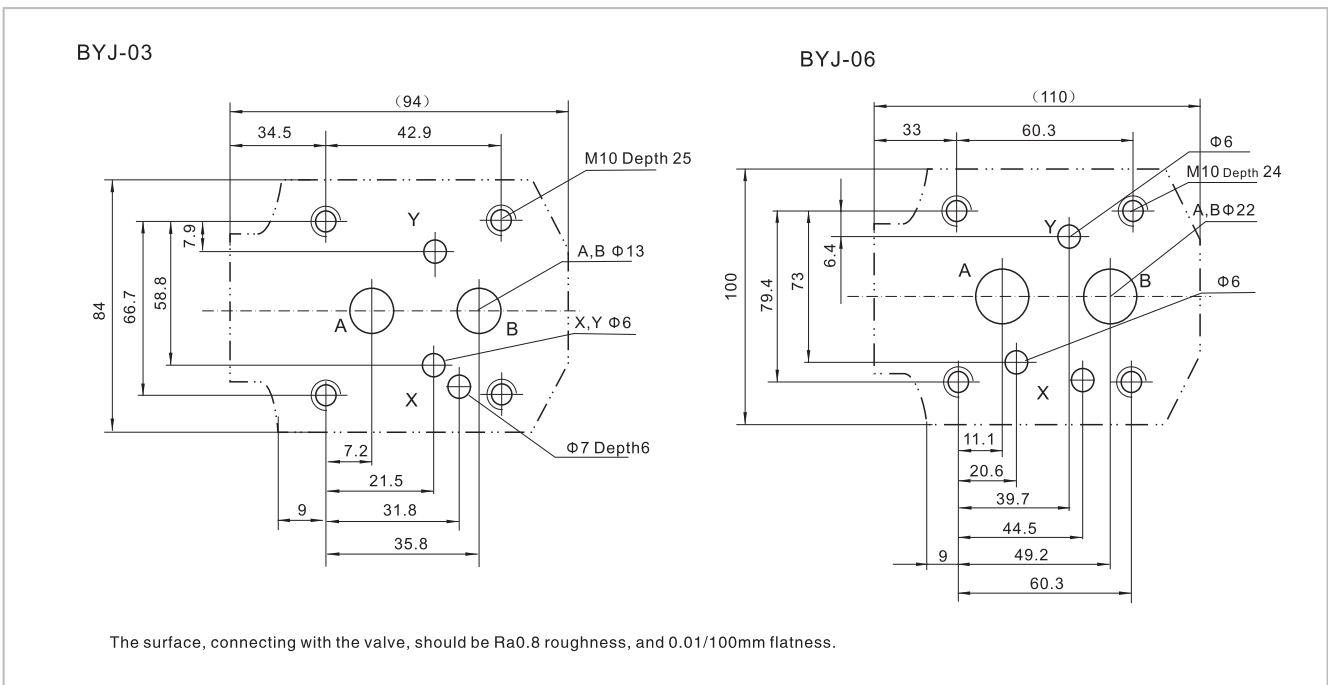

Plate size



Specification	B1	B2	H1	H2	H3	H4	L1	L2	L3	L4	L5
BYJ-03	85	66.7	190	92	28	72	90	42.9	-	35.5	34.5
BYJ-06	102	79.4	200	102	38	82	112	60.3	-	33.5	37